



# NT-1

Digital Audio Transport

USER MANUAL

Packing list . . . . .	01
Parts and names . . . . .	02
Front . . . . .	02
Rear . . . . .	03
Bottom . . . . .	05
Operations before using . . . . .	06
Connect to Network . . . . .	06
Connect to external clock . . . . .	06
MA Remote App . . . . .	06
Appendix . . . . .	07
Technical specifications . . . . .	07
Weight & size . . . . .	08
Precautions . . . . .	09

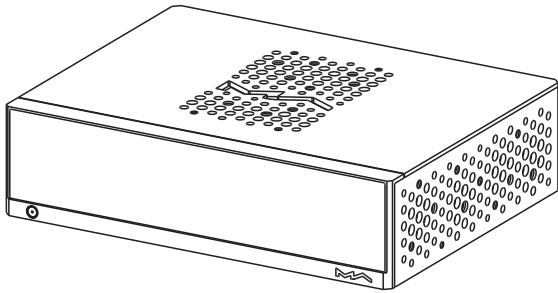

Product

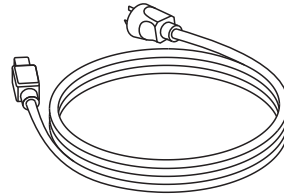

Power cable



Printed materials

## Front

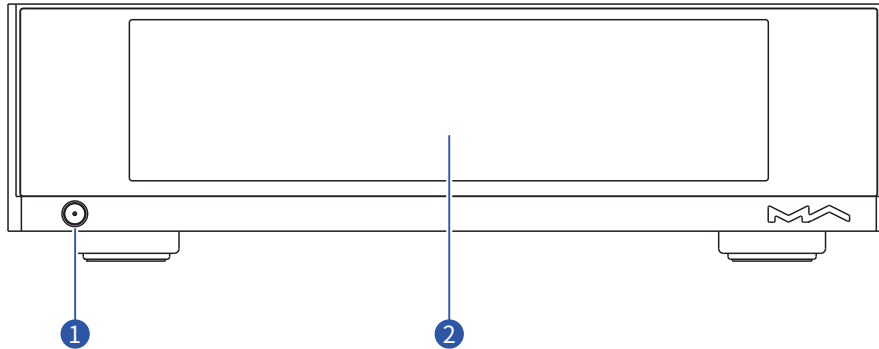

- 1 Power on/Standby**  
After connecting to power supply, press this button to power the device on, press it again to let the device standby. It will take about 30 seconds for the first start up after connecting to the power supply every time.
- 2 LCD screen**



- A Status info**  
Status including time, network connection, storage device, NAS and hardware functions.
- B Settings button**  
Tap on this button to enter the "Settings" menu and change the options of the device.
- C Information of audio**  
Including album art, track title, artist, duration, audio format, sampling rate and the filter type being used.
- D Playback control buttons**  
With these buttons, you can control the playback, enable and disable loop and shuffle, check the play queue and the playlists.
- E My favorites button**  
Add tracks to My favorites or remove tracks from My favorites by tapping on this button.
- F Control bar**  
Input channel : Select the input channel.  
Output channel : Select the output channel.  
Volume and mute : When digital volume function is enabled, use this button to change the volume or mute. When digital volume function is off, this button will not be displayed.

## Rear

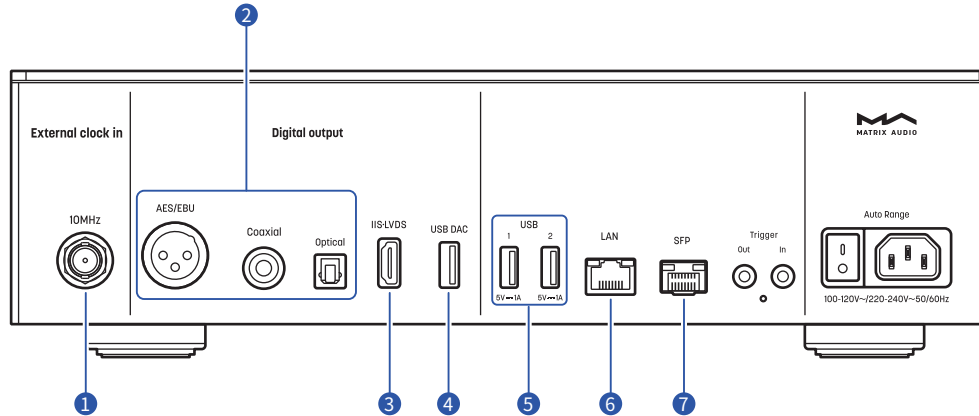

### 1 External clock input

To use external clock input, connect the external clock source to the device through a coaxial cable with 50Ω impedance. Then turn to the settings menu from the device and choose "External clock".

### 2 Optical, coaxial and AES/EBU outputs

The optical, coaxial and AES/EBU ports output up to 24bit/192kHz PCM signals in S/PDIF standard and 1bit/DSD64 signals via DoP.

Note : When the sampling rate of the played audio file exceeds the maximum capability of the output port, the output will be turned off.

### 3 IIS-LVDS Output

The IIS-LVDS port outputs maximum 32bit/768kHz sampling rate PCM signals, DSD64/128/256/512 signal in Native DSD standard, and DSD64/128/256 signal via DoP.

Connect to DACs with IIS-LVDS input port from Matrix Audio or other compatible devices through HDMI cables. The device features 4 kinds of IIS-LVDS pin definitions, which can be viewed and configured from the MA Remote App.

The ground wire of the IIS-LVDS port is isolated from the ground wire of the device.

### 4 USB DAC output

An external USB DAC can be connected to the product via this port. The audio specs depend on the external DAC.

This port provides up to 5V/1A low noise power to the external USB DACs.

Note : When the output channel is set to USB DAC, the optical, coaxial and AES/EBU outputs will be turned off. The two output categories can't work at the same time.

### 5 USB

Connect to USB storage devices or CD drives. Each USB ports provide a maximum 5V/1A power.

### 6 LAN

Connect to LAN port of the network router, the connection supports Gigabit transmission.

### 7 SFP slot

SFP optical or SFP to RJ45 modules can be plugged into this slot. The connection supports Gigabit transmission.

## Rear

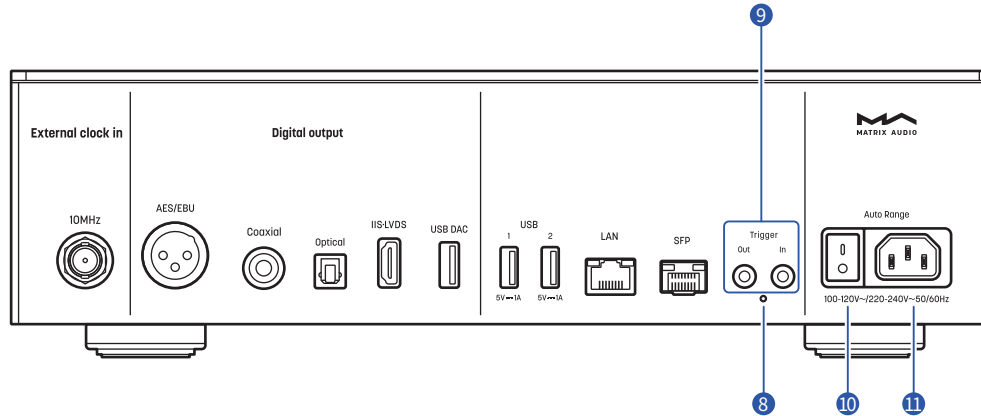

### 8 Reset button

Only use this button when the unit works incorrectly, the unit can be reset to factory state. Please operate under the instructions by service team from Matrix Audio.

### 9 Trigger input/output

Connect to audio devices with trigger ports through  $\varnothing 3.5\text{mm}$  mono plug cables, to achieve linkage control between the element device and other devices. The trigger output provides a 12V DC signal.

### 10 Power switch

If you need the device to be turned off completely, please turn off this switch. Otherwise, the device still consumes power in standby mode.

### 11 Power input

Please use a power cable which includes an earth wire and ensure you have a reliable earth wire connection. Otherwise, the casing of the device may have a slightly charged touch.

## Bottom

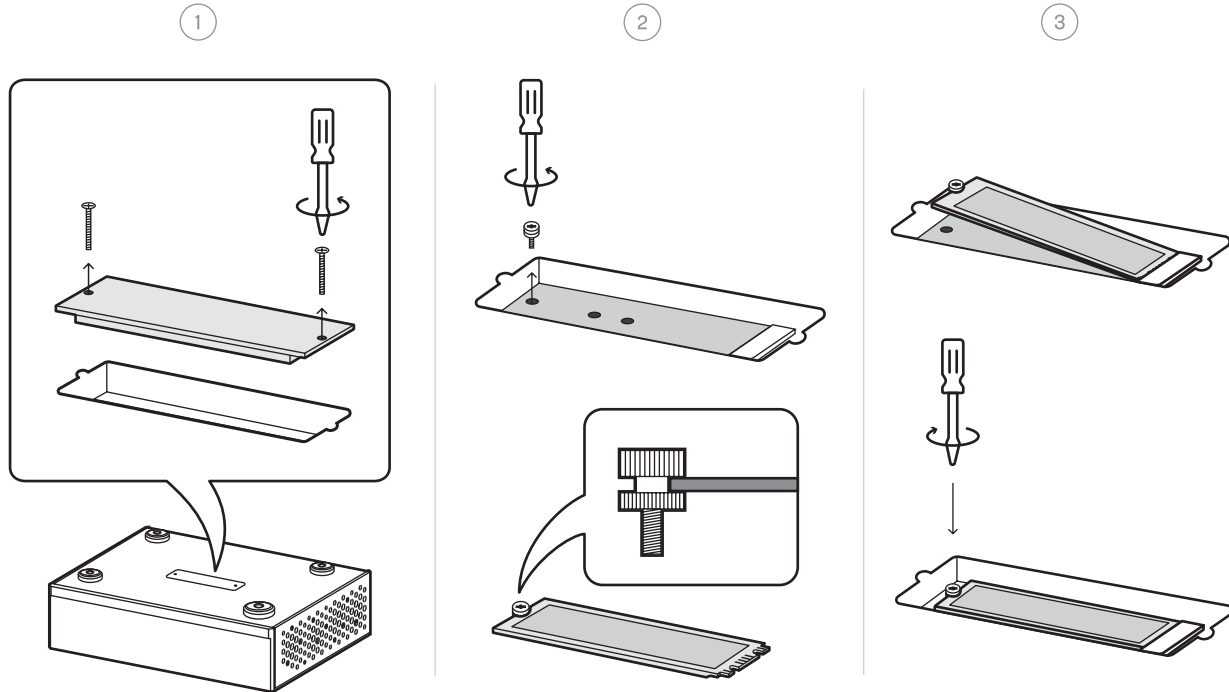

### SSD slot

You can install an NVMe protocol high-speed SSD as internal storage. The slot supports 2280, 2260, and 2240 SSDs.

Please turn off and unplug the power cord the device before installing the SSD. This expansion slot does not support hot swapping. Operating while powered on may risk damaging the SSD and the device.

After installing SSD and turning on the device, the device will notify you to format the SSD. It is recommended to format it on device to avoid compatibility issues. If the SSD has already been formatted before installation, the system will not prompt you to format. You can check and format the drive through the "Internal Storage" option in the device setting menu.

**\*Note:** The device supports a maximum power specification of 3.3V/3A for the SSD. Using an SSD with a working current exceeding 3A may cause instability. Please verify and confirm this information on the label of your SSD.

## Connect to Network

### LAN

Connect the product to the LAN port of the network router through an Ethernet cable. It is recommended to set up the router as a DHCP server, the device will be assigned an IP address automatically. Select "LAN" in option Network in Settings menu, you can configure the network specs manually, after joining the network, there will be an  icon shown in the status bar. As shown below:

### SFP

Plug an SFP optical module or an SFP to RJ45 module, you'll be able to connect the device to network via optical or Ethernet cables. It is recommended to set up the router as a DHCP server, the device will be assigned an IP address automatically. Select "SFP" in option Network from Settings menu, you can configure the network specs manually, after joining the network, there will be an  icon shown in the status bar. As shown below:

When the connection has no Internet access, there will be a  icon in the status bar, as shown below:

## Connect to external clock

If you want to use an external clock source, connect the external clock to the MS-1 through a 50Ω impedance coaxial cable, select "External clock" in the device settings menu. It supports 10MHz sine wave or square wave input. When the device detects an external clock signal, the icon  will be displayed on the status bar. When the option Reference Clock is set to "External Clock" while the clock device is not connected, music will not be played.

## MA Remote App

Install MA Remote App for your iPad, iPhone or Android phone.



Let the device on the same network as your phone or tablet, the MA Remote App will automatically discover and connect to the device. If you need to add the device manually, use the Add Device Wizard.



To control and configure the element devices through MA Remote App, or playback streaming music from the device, please refer to [matrix-digi.com/tutorials](http://matrix-digi.com/tutorials) for instructions.





## Technical specifications

### Digital Output

COAXIAL, OPTICAL & AES/EBU

PCM 16-24Bit /44.1kHz, 48kHz, 88.2kHz, 96kHz, 176.4kHz, 192kHz

DSD 2.8MHz (DoP)

### IIS LVDS

PCM 16-32Bit /44.1kHz, 48kHz, 88.2kHz, 96kHz, 176.4kHz, 192kHz, 352.8kHz,  
384kHz, 705.6kHz, 768kHz

DSD 2.82MHz, 3.07MHz, 5.64MHz, 6.14MHz, 11.29MHz, 12.29MHz, 22.58MHz,  
24.58MHz

### USB DAC

Depends on the specifications supported by the connected USB DAC device.

Not higher than PCM 32Bit/768kHz and DSD 24.58MHz.

The USB DAC port provides a maximum of 5V/1A low-noise power supply.

### Network

LAN : 10/100/1000 Mbps

SFP : 10/100/1000 Mbps

### USB

USB 3.0 x 2

The USB port provides a maximum power of 5V/1A.

The USB port works with devices which conform to the USB mass storage standard and supports FAT, FAT32, exFAT, and NTFS file formats, but is not guaranteed to be compatible with all storage devices.

### External Clock Input

10MHz / 50Ω / Sine wave or square wave input.

### Trigger

Trigger in : DC 6-12V <10mA

Trigger out : DC 12V/50mA MAX

### Storage Extension

M.2 2280 2260 2240 NVMe PCIe SSD slot x1

The maximum power specification provided by the expansion slot is DC 3.3V/3A.

### MA Player

Controller app : MA Remote App

Local Playback

Format Supported : Mp3 , WMA , WAV , AIF, AIFC, AIFF, AAC, FLAC, OGG, APE, ALAC,  
M4A, DSF, DFF, CUE, ISO

PCM 16-24Bit/44.1kHz, 48kHz, 88.2kHz, 96kHz, 176.4kHz, 192kHz, 352.8kHz,  
384kHz, 705.6kHz, 768kHz

DSD 2.82MHz, 3.07MHz, 5.64MHz, 6.14MHz, 11.29MHz, 12.29MHz, 22.58MHz,  
24.58MHz

Roon Ready

PCM 16-24 Bit /44.1kHz, 48kHz, 88.2kHz, 96kHz, 176.4kHz, 192kHz, 352.8kHz,  
384kHz, 705.6kHz, 768kHz

DSD 2.82MHz, 5.64MHz, 11.29MHz, 22.58MHz

QQMusic, AirPlay 2, DLNA/UPnP, TIDAL Connect, Spotify Connect, vTuner, Radio Paradise  
The audio specs depend on the service provider.

## Power Specs

Power Voltage : AC 100V-120V 50/60Hz or AC 220V-240V 50/60Hz, Auto Range  
Standby Power Consumption : < 5W  
Maximum Power Consumption : < 50W

## Weight & size

Weight : 4.6 kg (10.14 pounds)  
Size : Width : 330 mm (12.99 inches)  
Depth : 267 mm (10.51 inches)  
Height : 97 mm (3.82 inches)

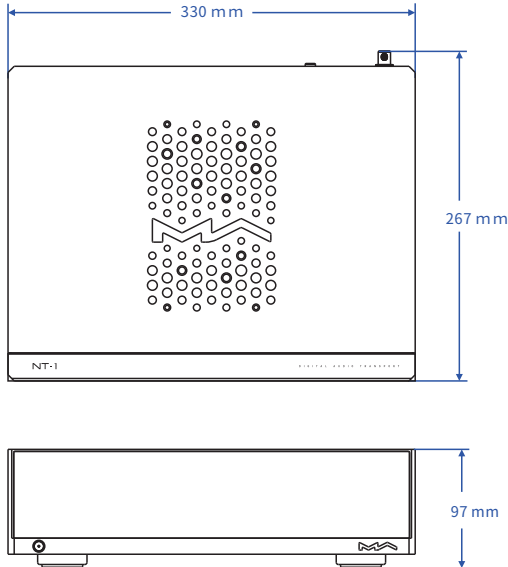

## About Roon Ready

Being Roon Ready means that Matrix Audio music streamers transparently discover and connect to Roon without any configuration, and bit-perfect audio is delivered from Roon to your music streamer.

## About Spotify

Use your phone, tablet or computer as a remote control for Spotify. Go to [spotify.com/connect](https://spotify.com/connect) to learn how. The Spotify Software is subject to third party licenses found here: <https://www.spotify.com/connect/third-party-licenses>.

\*For improvement purpose, specifications subject to changes without prior notice.

- This product is for indoor use only.
- For full ventilation, it is recommended to reserve a space of larger than 5 cm around the device.
- Do not cover the air vents with stuffs such as papers, tablecloths, and curtains to obstruct ventilation.
- Do not place stuff with flame, such as lighted candles, on the device.
- If the device is used in tropical areas, please be careful to prevent insects from entering the unit through the air vents.
- The device must not be subject to water droplets or splashes. Please do not place stuffs filled with liquids such as vases and cups on or near the device.